

Gary R. Gray © 2003 • University of Minnesota

A1

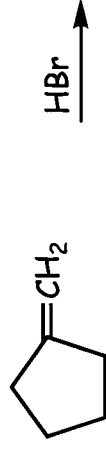

Gary R. Gray © 2003 • University of Minnesota

A2

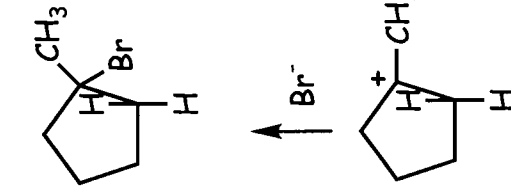

Answer:

NOTE: Markovnikov addition

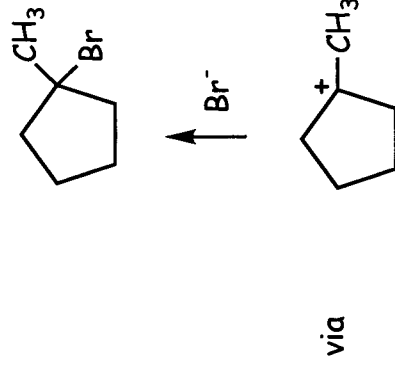

Answer:

NOTE: Markovnikov addition

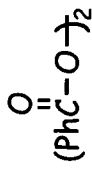
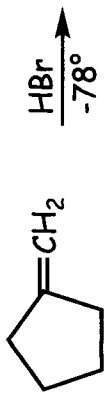

or

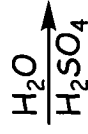
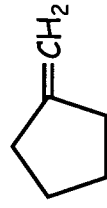
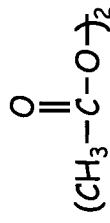

Answer:

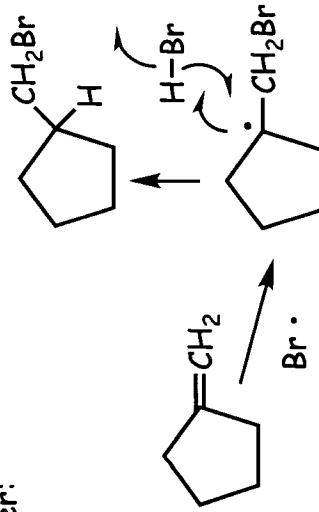

Answer:

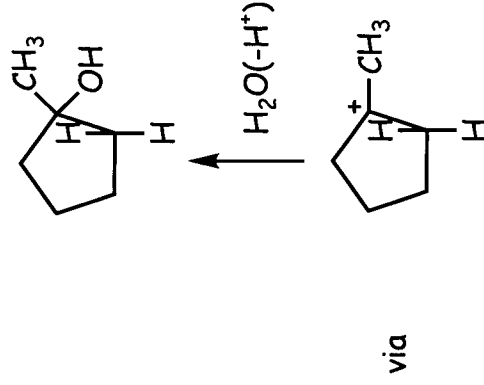

via

NOTE: Markovnikov addition

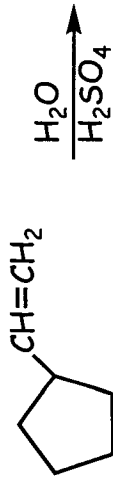

Gary R. Gray © 2003 • University of Minnesota

A5

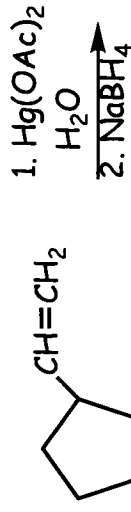

Gary R. Gray © 2003 • University of Minnesota

A6

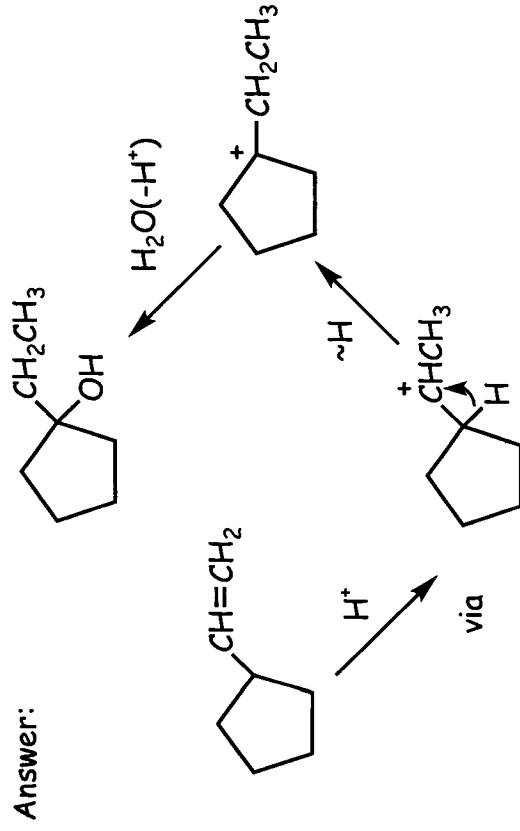

NOTE: Markovnikov addition with rearrangement

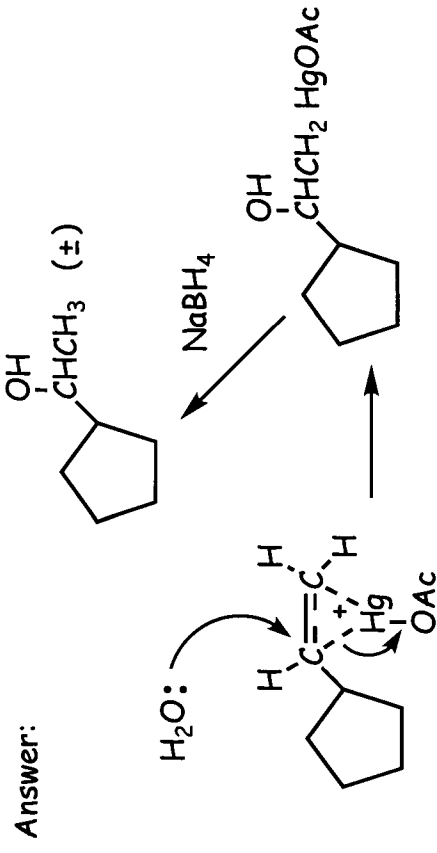

NOTE: Hydroxymercuration/demercuration

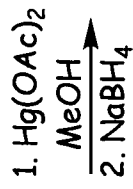
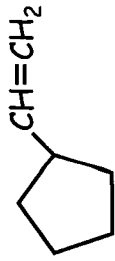

Gary R. Gray © 2003 • University of Minnesota

A7

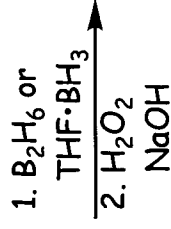
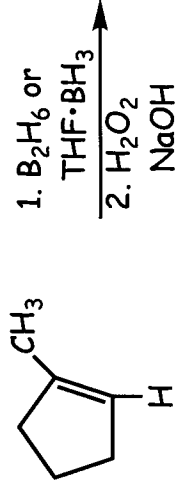

Gary R. Gray © 2003 • University of Minnesota

A8

Answer:

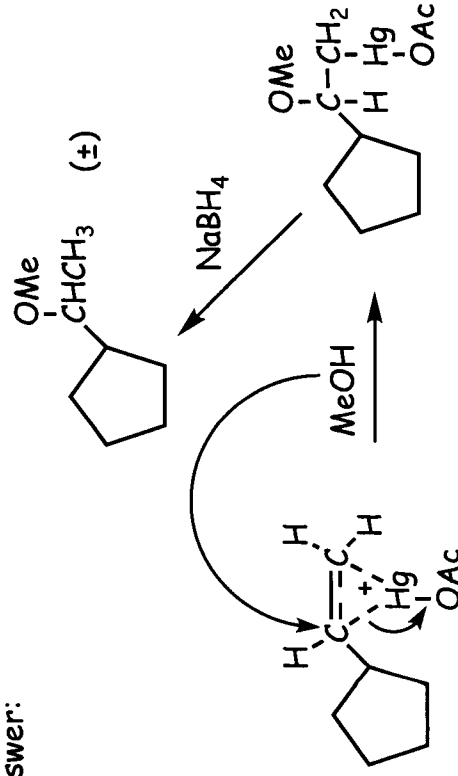

NOTE: Alkoxymercuration/demercuration

Answer:

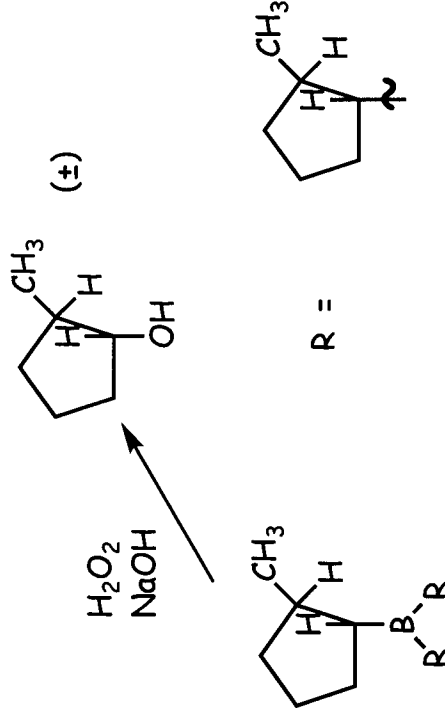

NOTE: Hydroboration/oxidation - syn addition

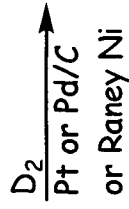
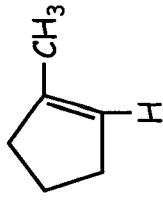

Gary R. Gray © 2003 • University of Minnesota

A9

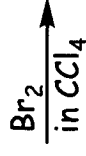
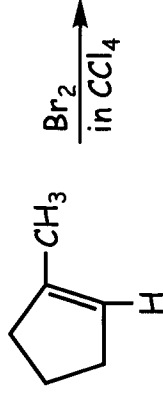

Gary R. Gray © 2003 • University of Minnesota

A10

Answer:

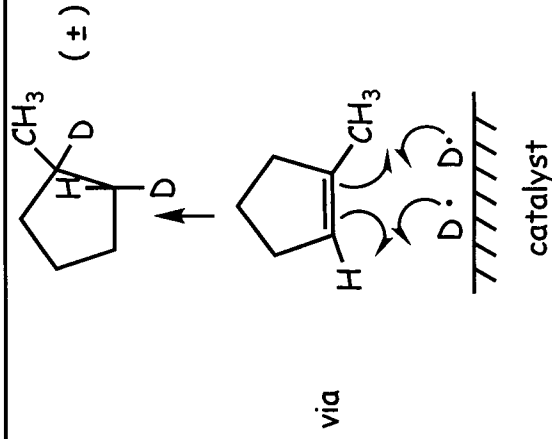

NOTE: Catalytic hydrogenation - syn addition

Answer:

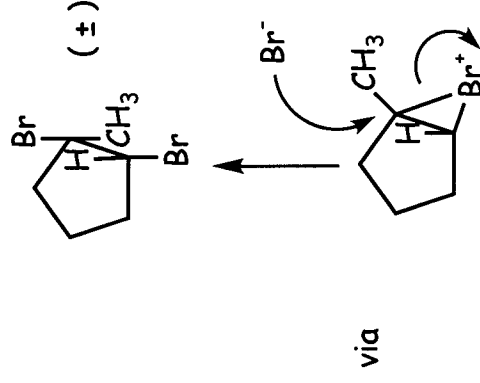

NOTE: Bromination-anti addition

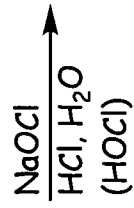
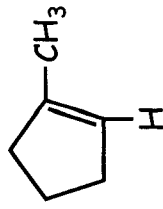

Gary R. Gray © 2003 • University of Minnesota

A11

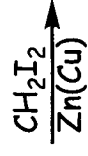
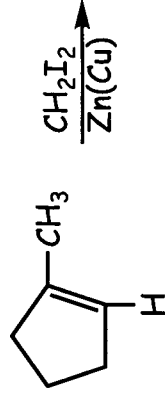

Gary R. Gray © 2003 • University of Minnesota

A12

Answer:

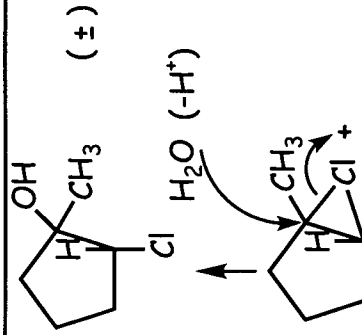

via

Answer:



(±)

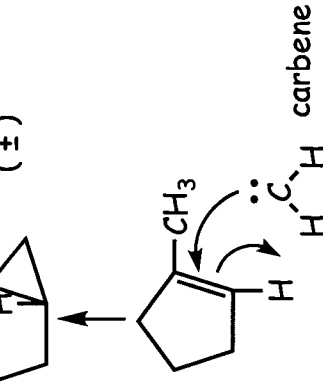

carbene

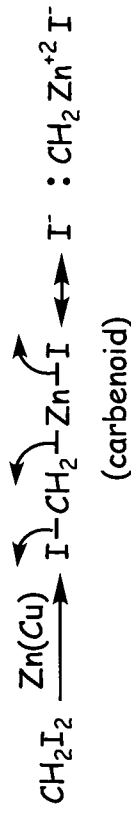

NOTE: Hydrochlorination - anti addition (Markovnikov)

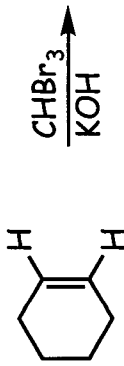

Gary R. Gray © 2003 • University of Minnesota

A13

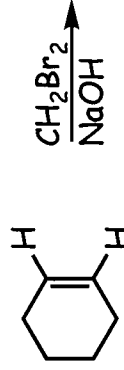

Gary R. Gray © 2003 • University of Minnesota

A14

Answer:

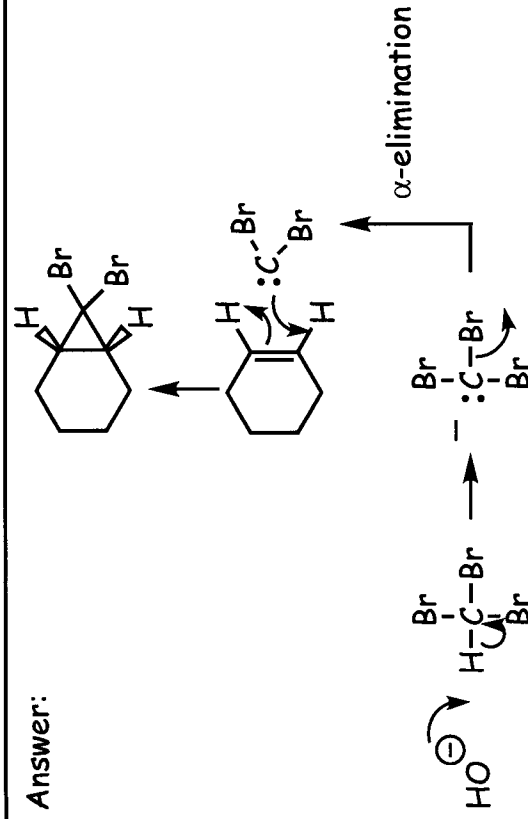

NOTE: Dibromocarbene is the electrophile

Answer:

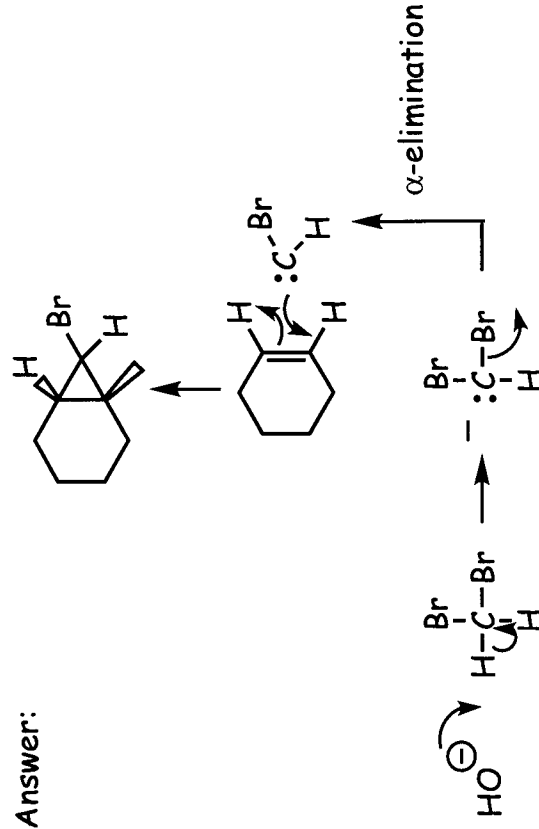

NOTE: Bromocarbene is the electrophile

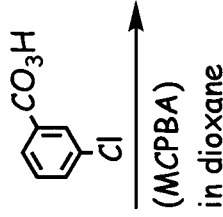
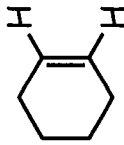

Gary R. Gray © 2003 • University of Minnesota

A15

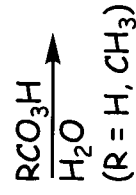
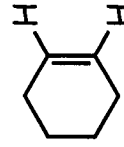

Gary R. Gray © 2003 • University of Minnesota

A16

Answer:

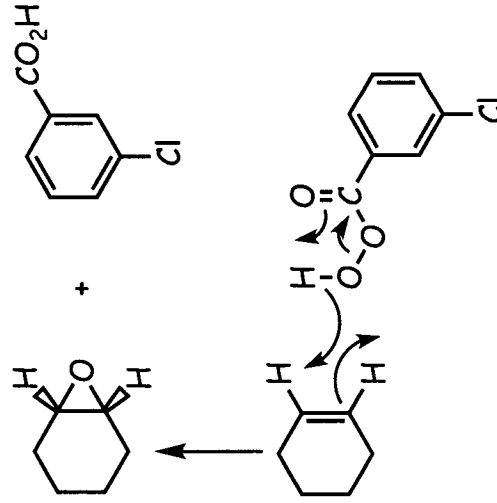

NOTE: Epoxidation reaction

Answer:

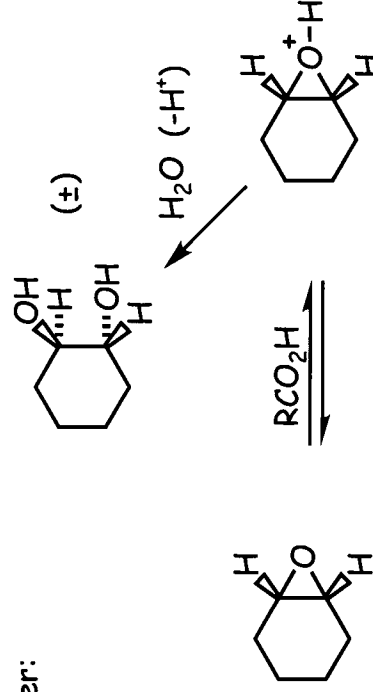

NOTE: Epoxidation followed by hydrolysis of the oxirane (anti-hydroxylation)

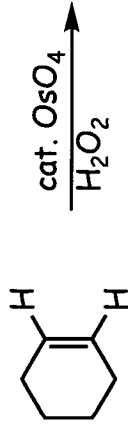

Gary R. Gray © 2003 • University of Minnesota

A17

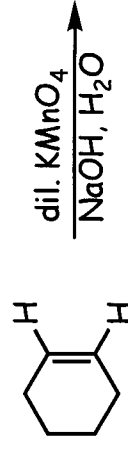

Gary R. Gray © 2003 • University of Minnesota

A18

Answer:

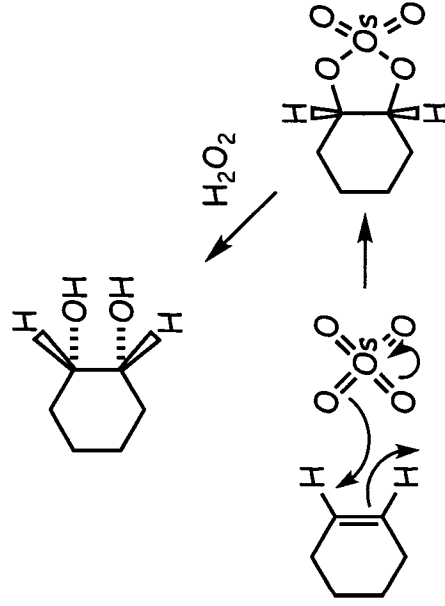

NOTE: *syn*-hydroxylation

Answer:

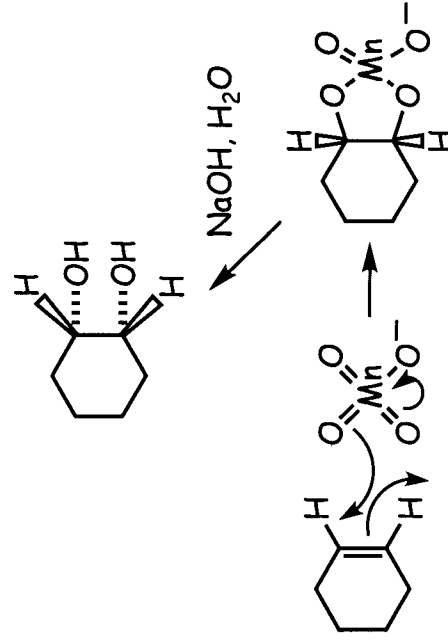

NOTE: *syn*-hydroxylation

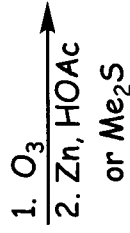
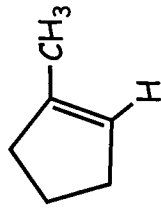

Gary R. Gray © 2003 • University of Minnesota

A19

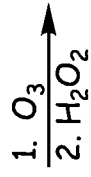
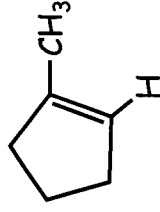

Gary R. Gray © 2003 • University of Minnesota

A20

Answer:

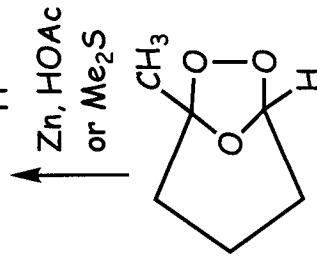
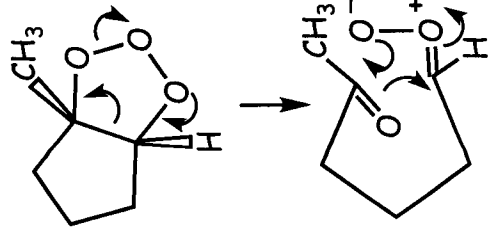

NOTE: Reductive Ozonolysis

Answer:

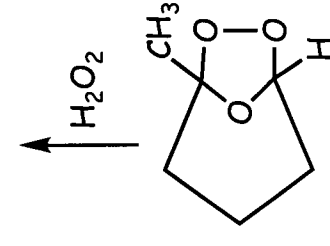
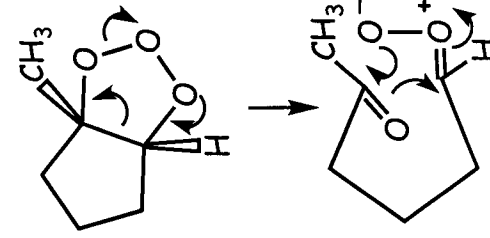

NOTE: Oxidative ozonolysis



Gary R. Gray © 2003 • University of Minnesota

A21

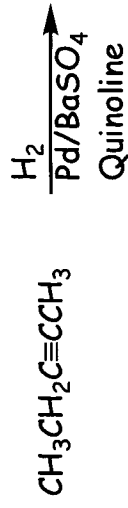

Gary R. Gray © 2003 • University of Minnesota

A22

Answer:

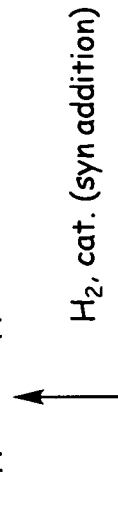
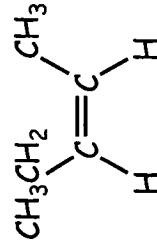
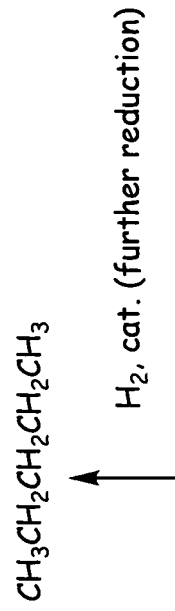

Answer:

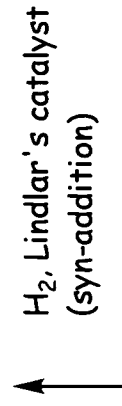
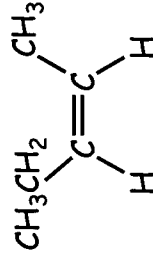

NOTE: Lindlar's catalyst can reduce alkynes to alkenes but can not reduce alkenes (poisoned catalyst).

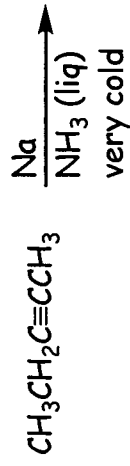

Gary R. Gray © 2003 • University of Minnesota

A23

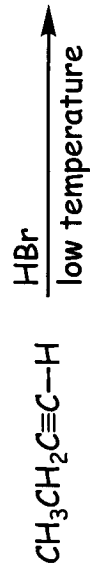

Gary R. Gray © 2003 • University of Minnesota

A24

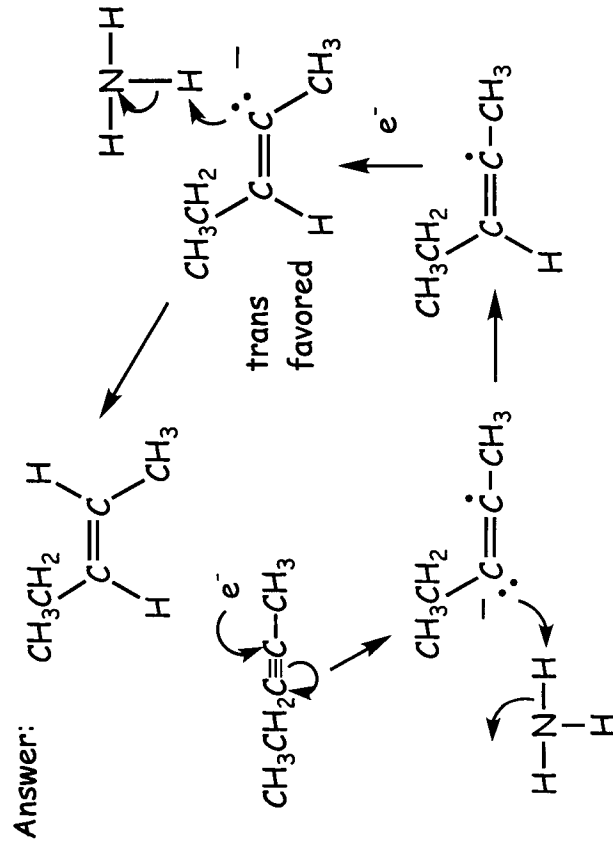

Answer:

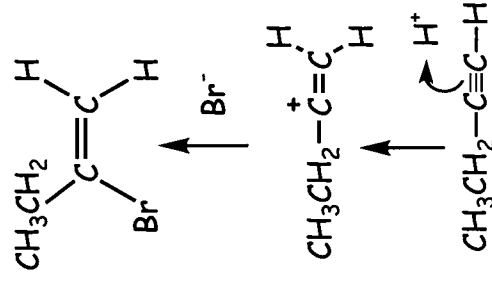

NOTE: Markovnikov addition

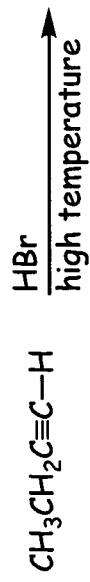

Gary R. Gray © 2003 • University of Minnesota

A25

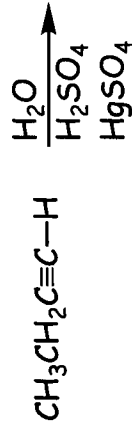

Gary R. Gray © 2003 • University of Minnesota

A26

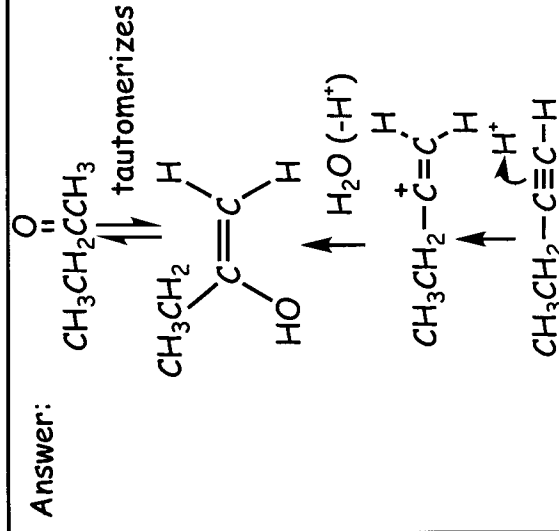
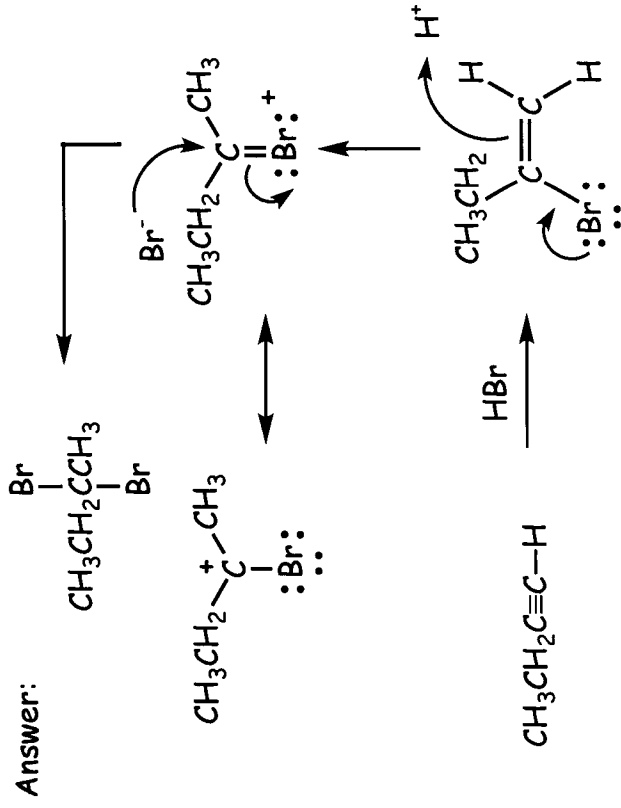

NOTE: Hg^{+2} catalyzes reaction; see text.

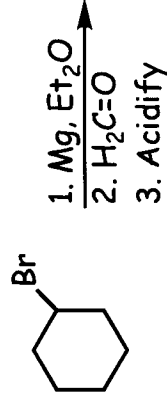
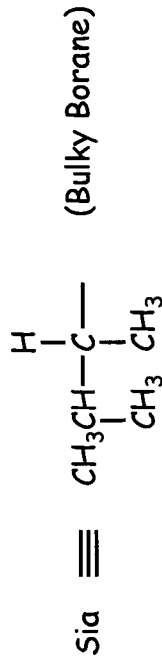
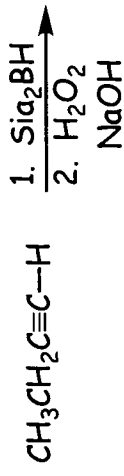

Answer:

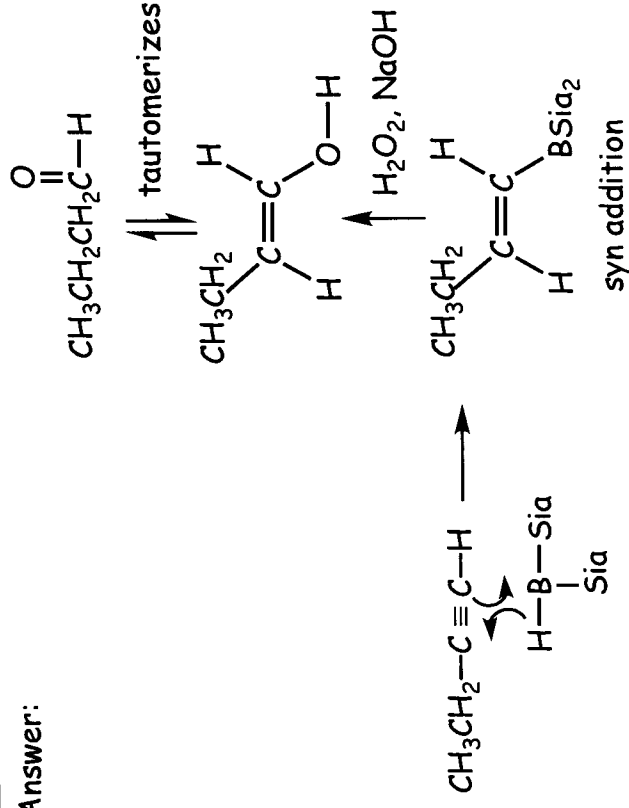

Answer:

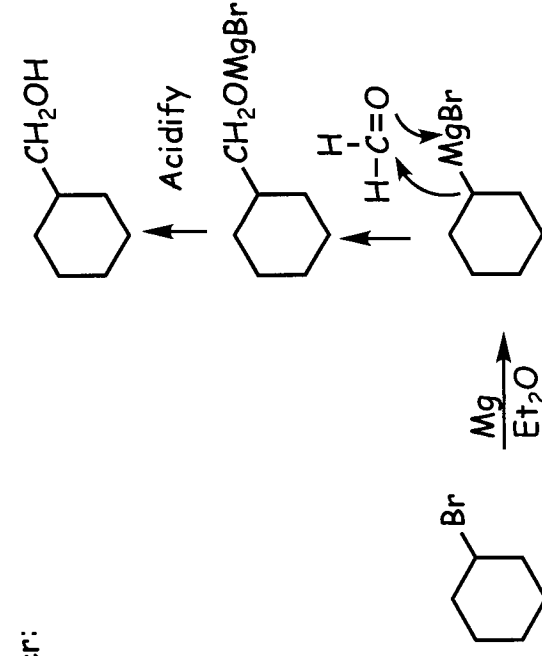

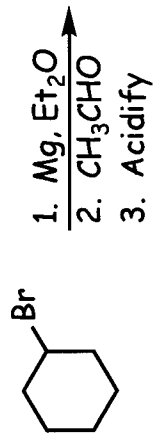

Gary R. Gray © 2003 • University of Minnesota

A29

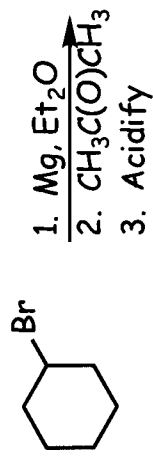

Gary R. Gray © 2003 • University of Minnesota

A30

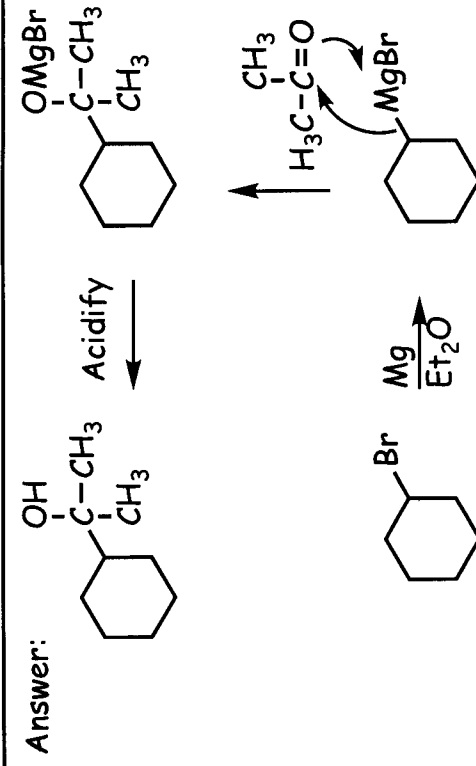
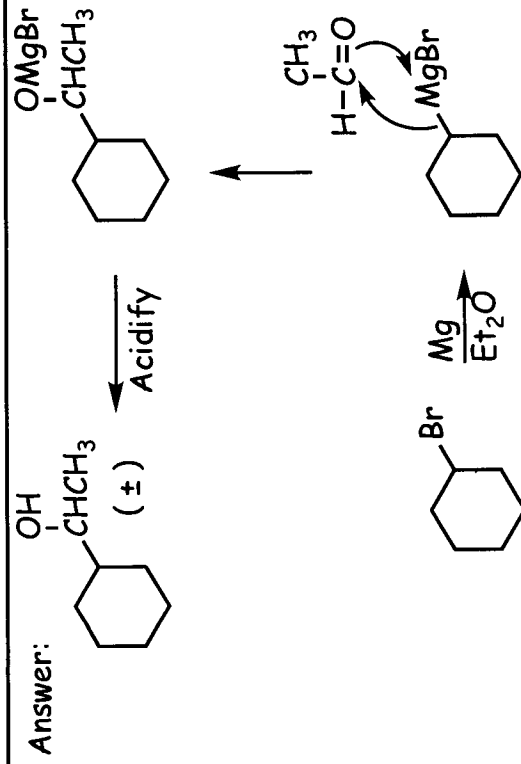

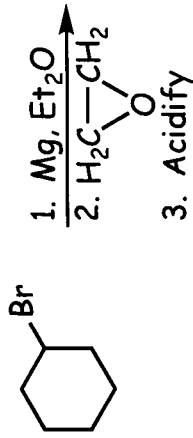

Gary R. Gray © 2003 • University of Minnesota

A31

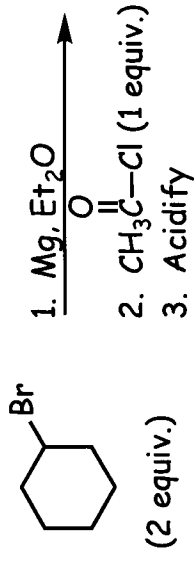

Note: Starting material in excess over acetyl chloride

Gary R. Gray © 2003 • University of Minnesota

A32

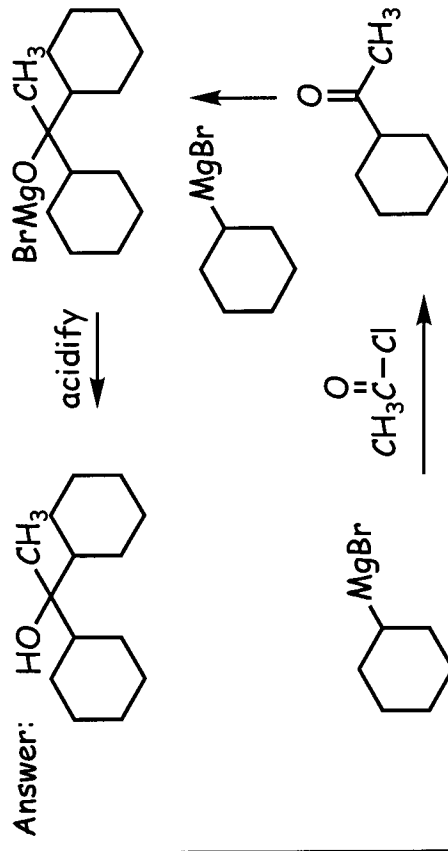
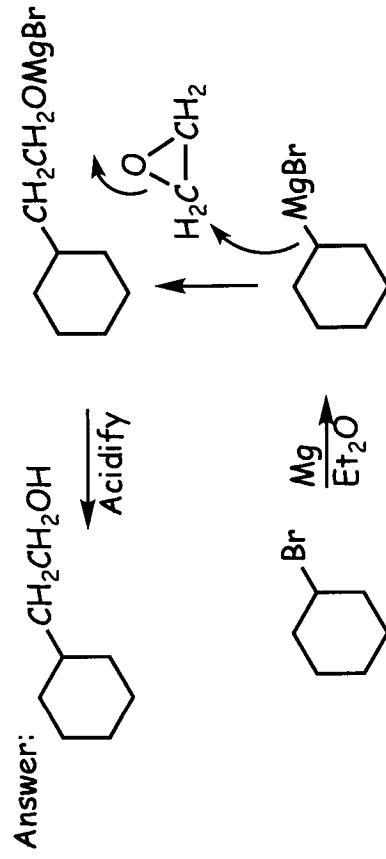

NOTE: See text for complete mechanism

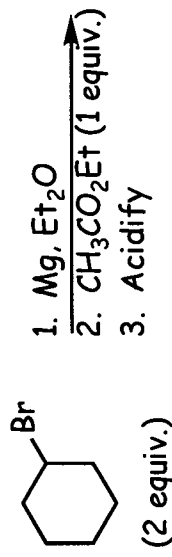

NOTE: starting material in excess over ethyl acetate

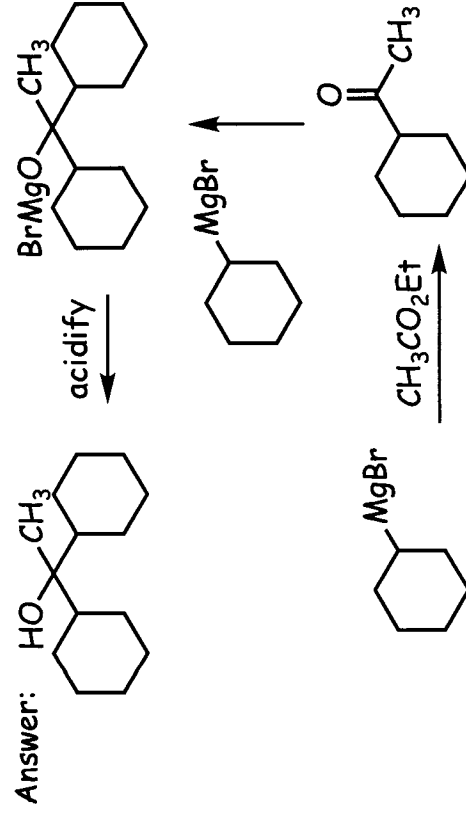
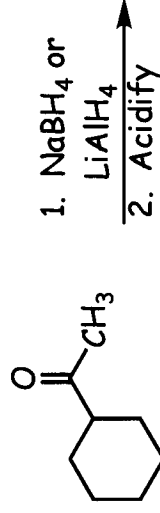

NOTE: See text for complete mechanism

Answer:

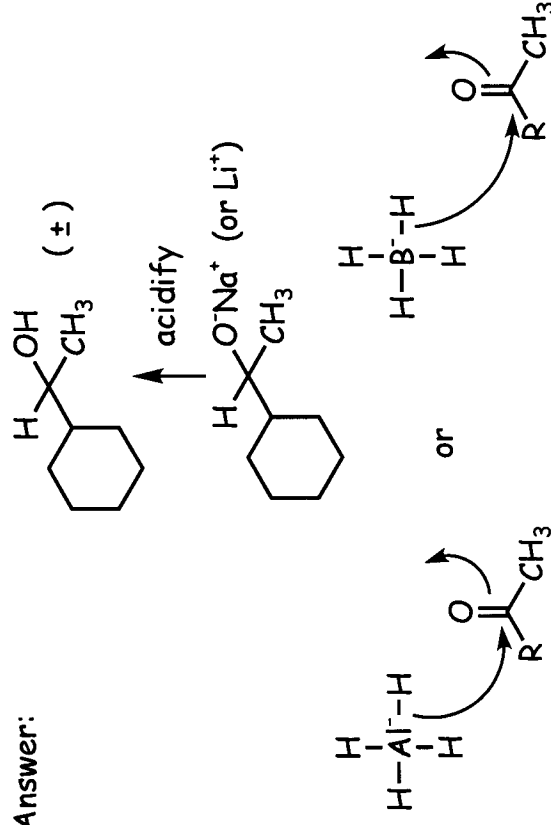

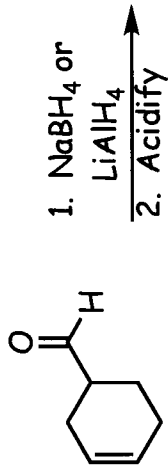

Gary R. Gray © 2003 • University of Minnesota

A35

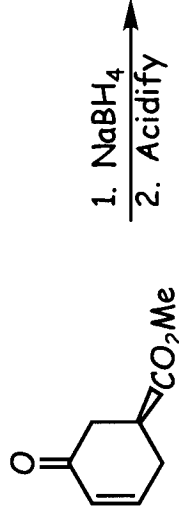

Gary R. Gray © 2003 • University of Minnesota

A36

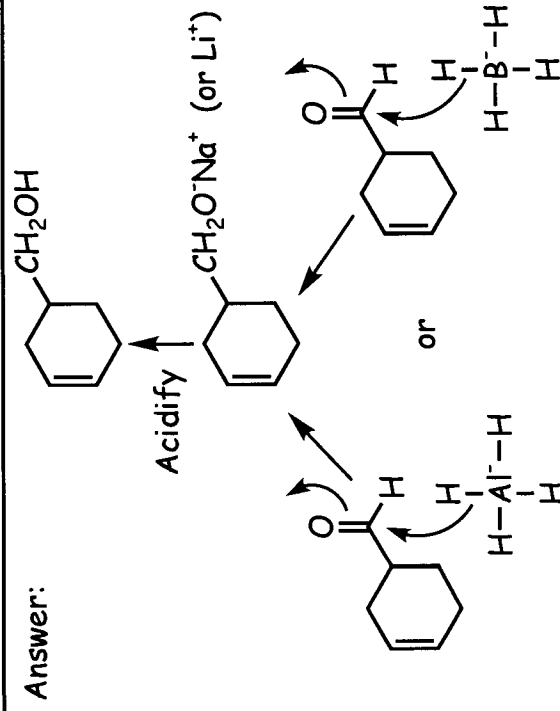

Answer:

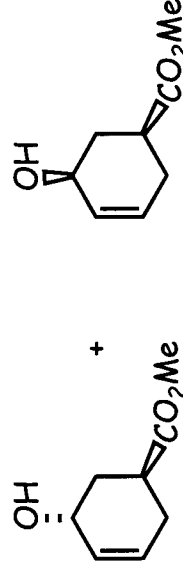

NOTE: NaBH_4 reduces aldehydes and ketones but does not reduce esters or alkenes.

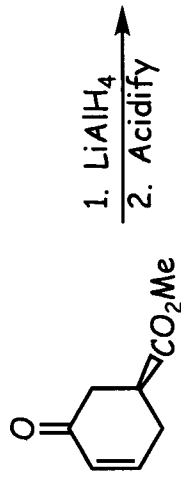

Gary R. Gray © 2003 · University of Minnesota

A37

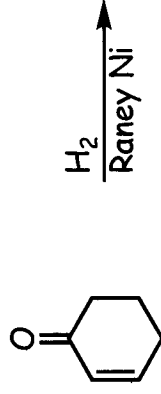

Gary R. Gray © 2003 · University of Minnesota

A38

Answer:

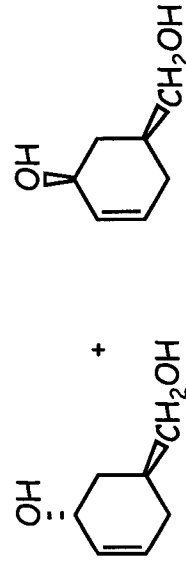

NOTE: LiAlH_4 reduces aldehydes, ketones, and esters but not alkenes.

Answer:

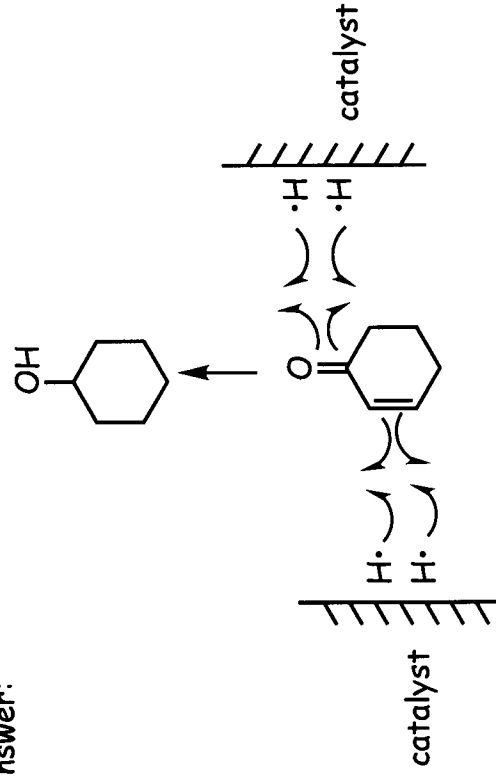

NOTE: Raney Ni and H_2 also reduces alkynes to alkanes